

ATLAS

R O A D C A M P

GoBOX-400 – Fixed Tube Assembly guide



TABLE OF CONTENT

WARNINGS	1
SAFETY WARNINGS	1
TECHNICAL WARNINGS	1
GENERAL WARNINGS	1
MAINTENANCE.....	1
PRIVACY POLICY	1
REQUIRED MATERIAL	2
SUPPLIED MATERIAL.....	2
REQUIRED TOOLS	3
SUPPLIED HARDWARE	5
GOBOX ASSEMBLY STEPS	7
1. Install steel hitch tube on the bottom panel	7
3. Install 2 reinforcement plates (at the back of the gobox).....	12
4. Install side door latch.....	13
5. Install 2 side door's hinges.....	14
6. Install side door onto the GoBOX	15
7. Install the cover baffle on Z-shaped plates	15
8. Install previous step assembly on the cover panel	16
9. Install main hinges on the cover panel	17
10. Install gaz spring (rear panel side).	17
11. Install cover panel on GoBOX	18
12. Install gaz spring (Cover side)	19
13. Install the lights and pass the 4-strand wiring over the steel tube in the bores provided.	20
14. Install the GoBOX on the vehicles hitch.....	22
15. Install the anti-rattle system from the hitch to the steel tube.....	22
ASSEMBLE BIKE RACK.....	23
A. Install the 2 cargo box to bike rack transition plates	23
B. Install rolled bar.....	24
C. Install stabilizer arm.....	24
D. Install gutters on box Z-plates.....	24
Securing the bicycles.....	27

WARNINGS

SAFETY WARNINGS

****ATLAS RC is not responsible for any injury resulting from the installation, maintenance or use of ATLAS RC accessories**.**

Initial assembly of a GoBox-400 may take 3 to 5 hours.

Always wear cut-resistant gloves and safety glasses.

2 people are recommended to lift panels at certain times.

If you have any hesitation during assembly, stop work and contact your dealer.

TECHNICAL WARNINGS

****FOR ALL BOLTS, IT IS MANDATORY TO APPLY THE ANTI-SEIZE SUPPLIED WITH YOUR HARDWARE TO ENSURE THAT THE BOLT/NUT ASSEMBLY DOES NOT SEIZE**.**

****It's important to ensure that the square of the carriage bolts is fully engaged in the square holes before tightening.****

- All bolts and nuts must be hand-tightened (using ratchets, Allen keys and torque wrenches) to the tightening torques given in the guide.
- Nylock nuts are used when assembling ATLAS accessories. Repeated tightening and loosening of this type of nut is not recommended. It is therefore very important to follow the tightening steps prescribed in this manual.

GENERAL WARNINGS

- It is your responsibility to validate that your vehicle hitch has the capacity to accommodate a GoBox-400 and its load.
- Maximum total useful load: 200 lbs (90kg)
 - Maximum of 55 lbs per bike (110 lbs total maximum bike weight)
- The locking handles of the bike rack must be locked at all times during transport to ensure they remain tight.
- ATLAS RC liability limitations: ATLAS RC is not responsible for damage resulting from misuse, overloading, improper assembly, abuse, accident, negligence, improper installation, theft, or unauthorized modifications.
- As the owner of an ATLAS RC accessory, it is your responsibility to review the company's Terms and Conditions on the website.
- Any modification or alteration of ATLAS RC accessories not approved by ATLAS RC may void the product warranty.
- Adding components not approved by ATLAS RC may void the product warranty.

MAINTENANCE

- All tightening torques should be checked after the first 100 km and 500 km of driving following installation of the accessory.
- Twice a year, check all hardware for tightness

PRIVACY POLICY

The customer is responsible for reading the "Privacy Policy" page of the Atlas Roadcamp website:

<https://atlasroadcamp.com/politique-de-confidentialite>

- ATLAS RC liability limitations: ATLAS RC is not responsible for damage resulting from misuse, overloading, improper assembly, abuse, accident, negligence, improper installation, theft, or unauthorized modifications.

REQUIRED MATERIAL

SUPPLIED MATERIAL

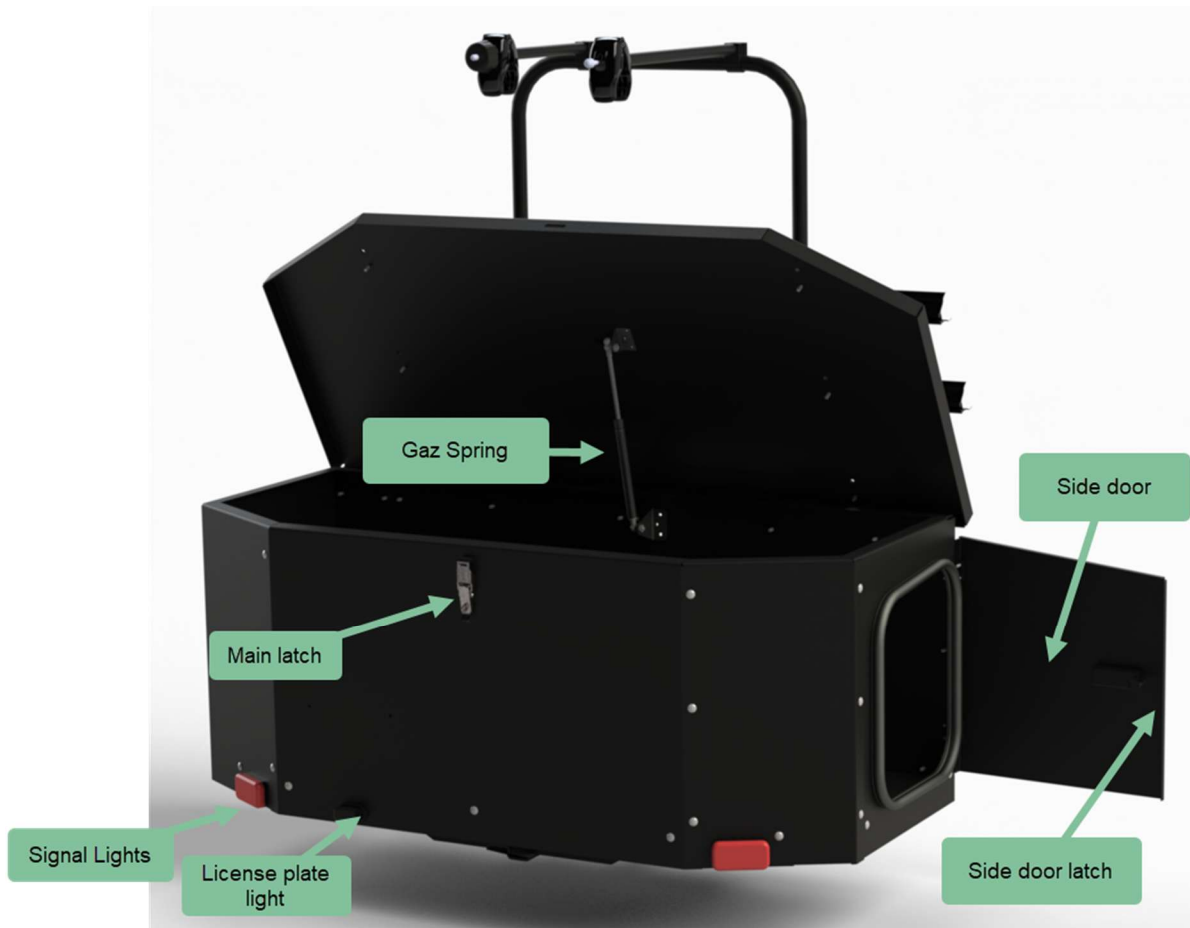
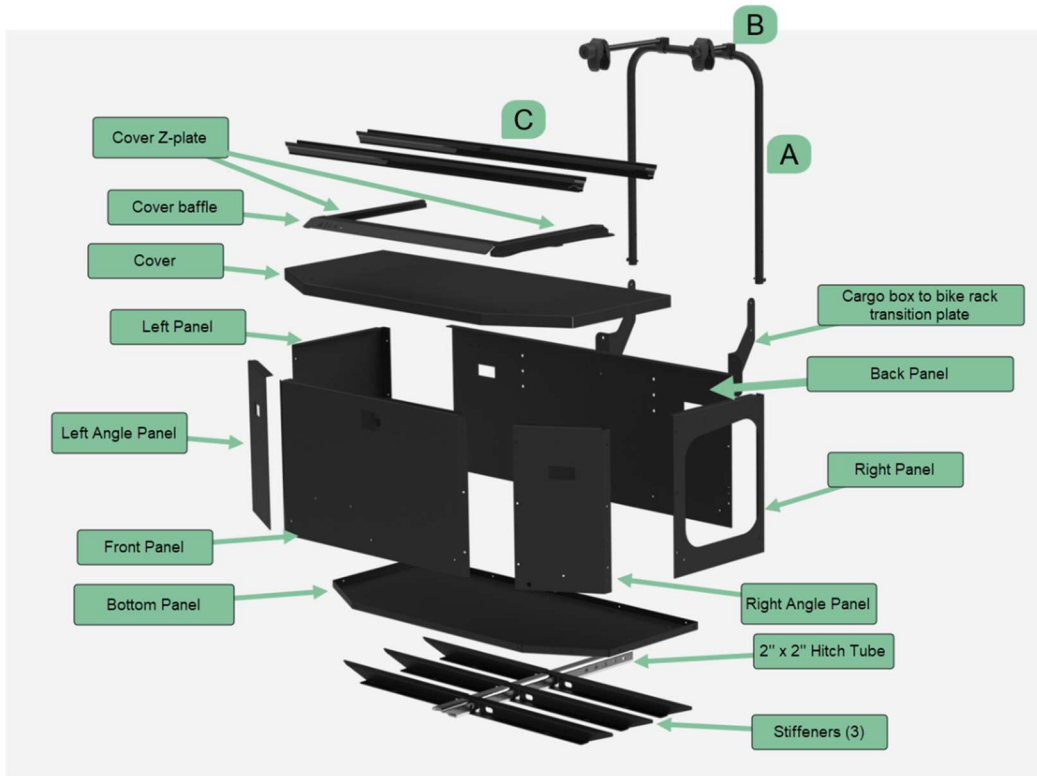

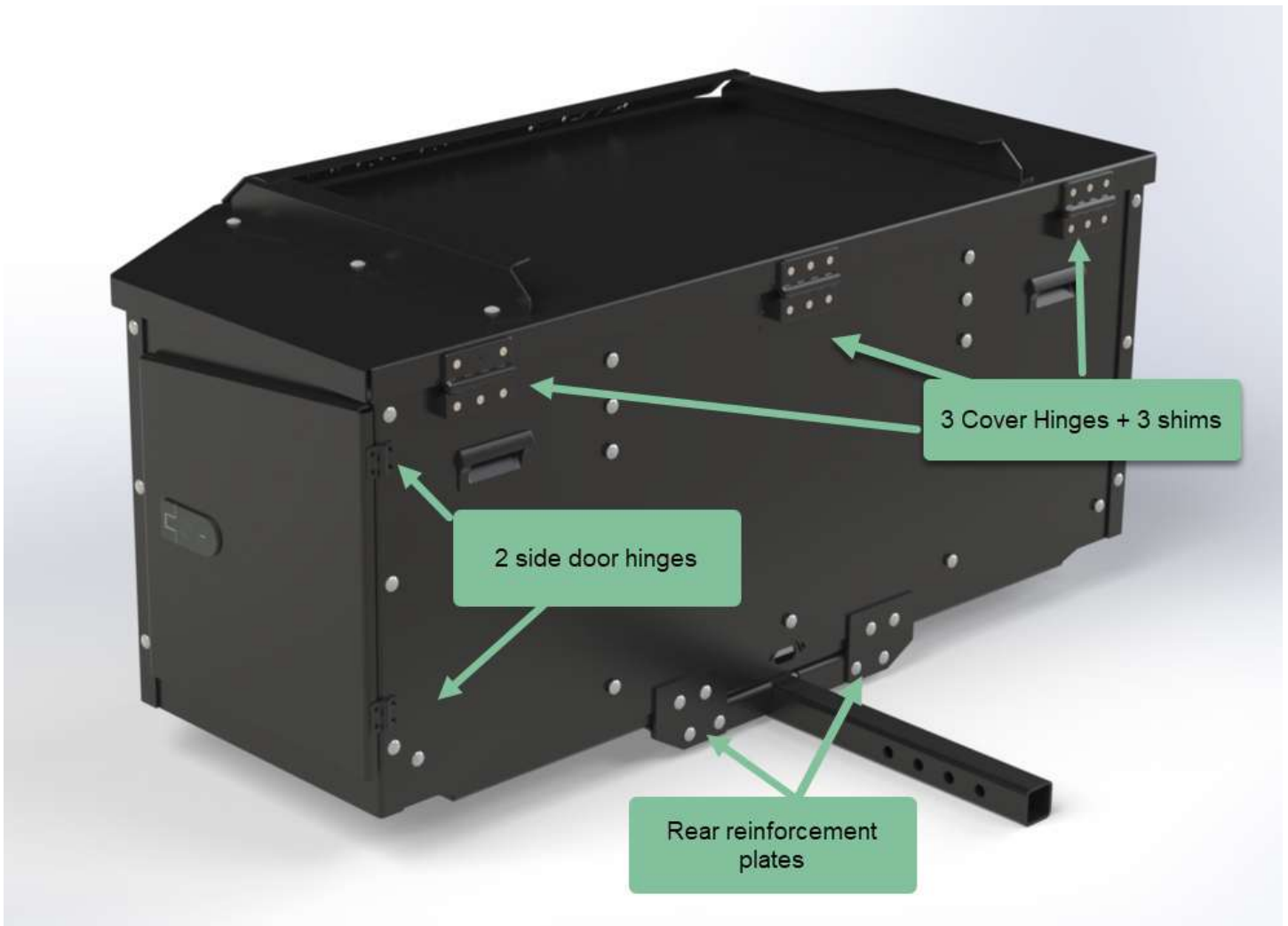





REQUIRED TOOLS

- 9/16" Socket - 3/8" Hardware
- 1/2" Socket - 5/16" Hardware
- 7/16" Socket - 1/4" Hardware
- 3/8" Socket - #10 Hardware
- Complete Allen key set

It is mandatory to comply with the prescribed tightening torques bolt diameters.

TORQUES

- 5/16" = 24Nm
- #10 = 3 Nm
- 1/4" = 12Nm
- 3/8" = 30 Nm

QTY	MATERIAL	Hardware image
1	Anti-rattle U-Bolt	
1	Complete signal and licence plate lights kit	
1	Side door latch	
3	Main hinges	
3	Main hinge's shims	
2	Side door hinges	
1	Gaz Spring	
1	5/8" hitch pin	
1	Main latch padlock	
1	Tie wraps set	



- Anti-Seize







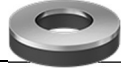



****IMPORTANT: Apply anti-seize to all bolt threads before engaging nuts. ****



SUPPLIED HARDWARE

There are a few extras in the hardware bags.

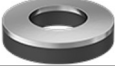
GOBOX - FIXE			
#	Qty	Description	Utilisation
Bag TUBE FIXE	14	Carriage bolt 5/16" X 1"	6 to install hitch steel tube
	14	Flat Washer 5/16"	8 to install rear reinforcement plates
	14	Nylock 5/16"	
BAG #1	32	Carriage bolt 5/16" X 3/4"	To install all the panels
	32	Flat Washer 5/16"	
	32	Nylock 5/16"	
Bag #2 2	12	Carriage bolt 5/16" X 3/4"	2 to fix baffle to Z-shaped plates, 6 to install box bike rack transition plates, 4 to install gutters to Z-shaped plates
	18	Flat Washer 5/16"	
	18	Nylock 5/16"	
	6	Button head bolt 5/16" X 3/4"	6 to install Z-shaped plates to box cover with 2 kind of sealing washers
	6	Sealing washer 5/16"	
	6	Sealing washer 5/16" in between plates	
Bag #3	8	Countersunk head bolt #10 X 3/4"	Side door hinges
	8	Nylock #10	
	8	Flat washer #10	
	6	Countersunk head bolt 1/4" X 5/8"	Main hinges – Cover plates
	6	Countersunk head bolt 1/4" X 1-1/4"	Main hinges – rear panel
	12	Flat Washer 1/4"	
	12	THIN Nylock 1/4"	
Bag #4	6	Button head bolt #10 x 5/8"	Gaz Spring
	6	Socket head bolt #10" X 3/4"	Signal and licence plate lights
	12	Nylock #10	
	12	Flat Washer #10	
	6	Sealing washer #10	
Bag #5	4	Carriage bolt 5/16" X 1-3/4"	To install bike rack roll bar to transition plates – pre-installed
	6	Hex head bolt 5/16" X 3/4"	To fill holes on rear panel of no bike rack is installed
	10	Nylock 5/16"	
	16	Flat Washer 5/16"	
Bag #6	2	Hex head bolt 1/4" X 3/4"	Licence plate
	2	Nylock 1/4"	
	7	Flat Washer 1/4"	

<p align="center">Carriage bolt</p> <p>Carriage bolt 3/8" X 1" Carriage bolt 5/16" X 3/4"</p>	
<p align="center">Button head bolts</p> <p>Button head bolt 5/16" x 3/4" Button head bolt #10 x 5/8"</p>	
<p align="center">Flat cap bolts (countersunk)</p> <p>Countersunk head bolt 1/4" X 5/8" Countersunk head bolt 1/4" X 1-1/4" Countersunk head bolt #10 X 3/4</p>	
<p align="center">Socket head bolts</p> <p>Socket head bolt #10" X 3/4"</p>	
<p align="center">Hexagonal head bolts</p> <p>Hex. Head bolt 5/16" X 3/4" Hex. Head bolt 5/16" X 1" 3/4"</p>	
<p align="center">Nylocks</p> <p>Nylock 3/8" Nylock 5/16" Nylock 1/4" Nylock #10</p>	
<p align="center">Flat washers</p> <p>Flat Washer 3/8" Flat Washer 5/16" Flat Washer 1/4" Flat Washer #10</p>	
<p>Thin Nylock 1/4" Thin Nylock M10</p>	
<p>Sealing washer 5/16"</p>	
<p>Sealing washer 5/16" in between Z-plates in cover panel</p>	
<p>Sealing washers #10 – For Gaz spring bolts</p>	

GOBOX ASSEMBLY STEPS

1. Install steel hitch tube on the bottom panel

****Pay attention to the orientation of the tube: it must protrude from the back of the box**.**

The bottom panel is the one with the stiffeners pre-installed.

Lay the tube and align the 6 holes with the stiffeners.

Insert the bolts into the holes.

Insert washers on bolts.

Apply anti-seize to bolts.

Hardware : **BAG TUBE FIXE**

6 Carriage bolt 5/16" X 1"

6 Flat washers 5/16"

6 Nylock 5/16"



1



2



3



4



5

2. Install all side panels (6)

Place bottom panel right side up (steel tube underneath)

Hardware bag #1

32 Carriage bolt 5/16" X 3/4"

32 Flat washer 5/16"

32 Nylock 5/16"

a. Install rear panel

Align the holes at the bottom of the rear panel with the rear holes on the bottom panel.

Insert the 5 bolts (bottom of rear panel) from the outside of the box to the inside.

Insert the flat washers inside the gobox on the bolts.

Apply anti-seize on the bolt threads.

Hand tightens the bolts. Leave the panel loose/flexible for easy installation of the other panels.

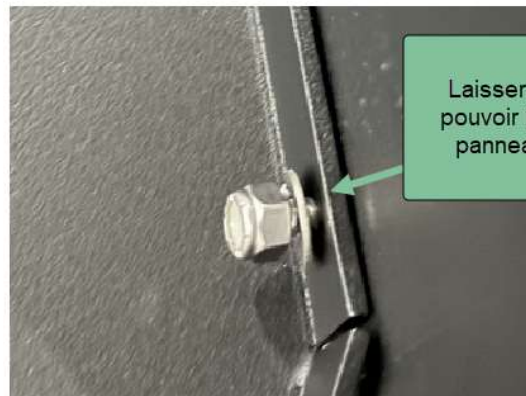
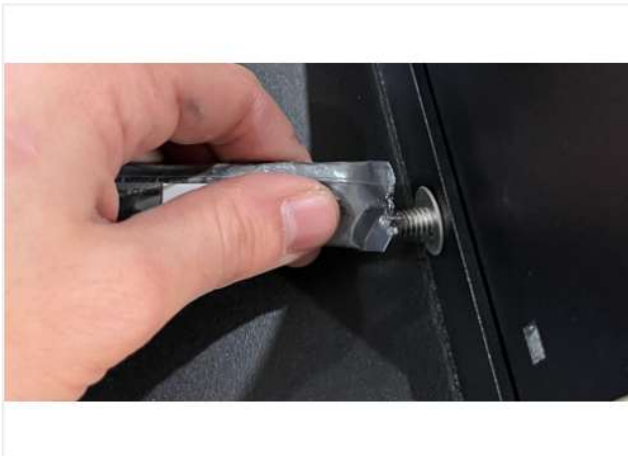
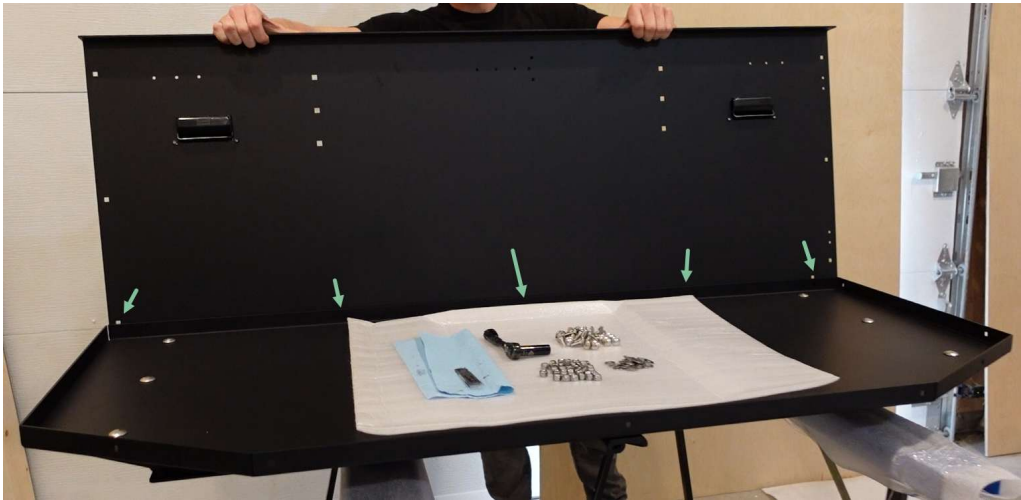

b. Install right-hand panel (door opening).

Align the holes in the right-hand panel with those in the bottom panel and those in the rear panel.
The right panel must overlap the rear panel.
Insert the 5 bolts from the outside in.
Insert washers on the inside of the bolts.
Apply anti-seize to bolt threads.
Tighten nuts by hand only. Leave panel loose.



c. Install the left-hand panel

Align the holes in the right-hand panel with those in the bottom panel and those in the rear panel.
The left panel must overlap the rear panel.
Insert the 5 bolts from the outside in.
Insert washers on the inside of the bolts.
Apply anti-seize to bolt threads.
Tighten nuts by hand only. Leave panel loose.

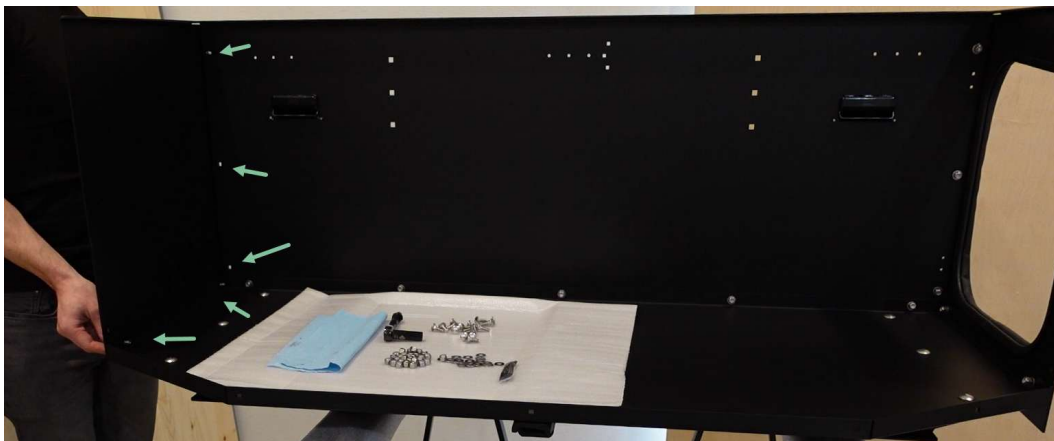



d. Install the right-angled panel

Align the holes in the right-angled panel with those in the panel below and those in the right-hand panel.

The right-angled panel must overlap the right-hand panel.

Insert the 4 bolts from the outside in.

Insert washers on the inside of the bolts.

Apply anti-seize to bolt threads.

Tighten nuts by hand only. Leave panel loose.



e. Install the left angled panel

Align the holes in the left-angled panel with those in the panel below and those in the left-hand panel.

The left-angled panel must overlap the left-hand panel.

Insert the 4 bolts from the outside in.

Insert washers on the inside of the bolts.

Apply anti-seize to bolt threads.

Tighten nuts by hand only. Leave panel loose.



f. Install the front panel (with main latch already installed)

Align the holes in the front panel with those in the bottom panel and those in the 2 angled panels.

The front panel must overlap the 2 angled panels.

Insert 9 bolts from outside to inside.

Insert washers on the inside of the bolts.

Apply anti-seize to bolt threads.

Tighten nuts by hand only. Leave panel loose.



- g. Tighten the 3/2, 5/16" x 3/4" carriage bolts. It is important that the square guide of the bolt head is well inserted into the square bore before tightening.



3. Install 2 reinforcement plates (at the back of the gobox)

Hardware : Bag TUBE FIXE

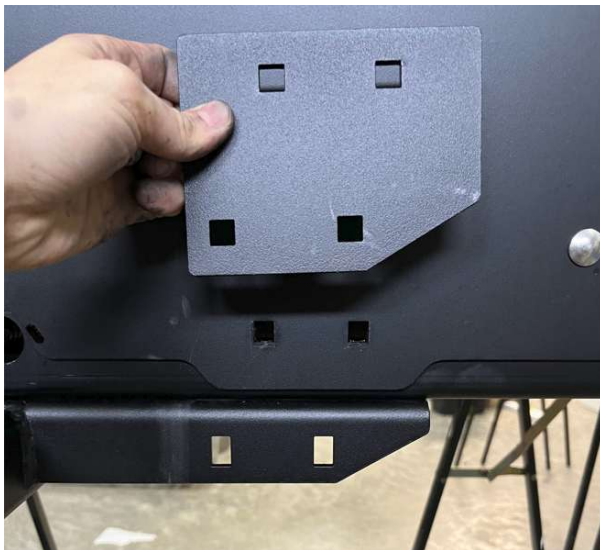

4. Install side door latch

Unscrew the hex head bolt with the U-shaped bracket and remove.
Insert the latch into the side door panel.

Remove 2, ¼" washers under U-shaped plate and 1, ¼" washer under bolt head (see photos).
Tighten the bolt to finalize installation of the side door latch.

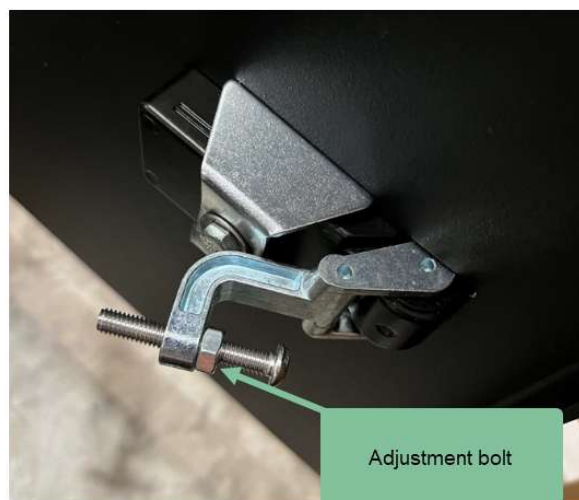
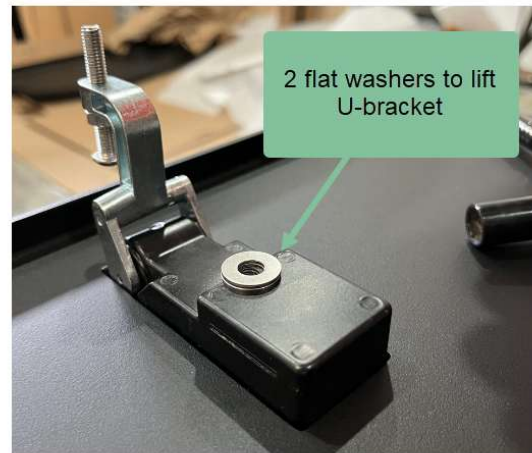
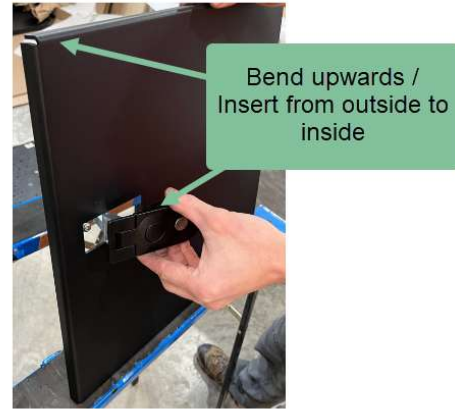
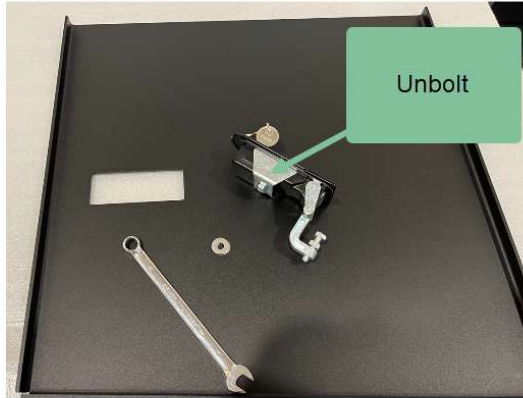

5. Install 2 side door's hinges.

Hardware bag #3

2 small hinges (side door's)

4 Countersunk head bolt #10 X 3/4

4 flat washers #10

4 Nylock #10

**** Respect prescribed torque****

**** DO NOT OVERTIGHTEN, the bolt head should be slightly recessed in the hinge. ****

Insert the 2 bolts per hinge.

Insert the hinges with the bolts on the side door.

Insert washers inside bolts.

Apply anti-seize to bolt threads.

Tighten nuts



1



2



3

6. Install side door onto the GoBOX

Hardware bag #3

4 Countersunk head bolt #10 X 3/4

4 flat washers #10

4 Nylock #10

**** Respect prescribed torque****

**** DO NOT OVERTIGHTEN, the bolt head should be slightly recessed in the hinge. ****



1



2



3



4

7. Install the cover baffle on Z-shaped plates

Hardware bag #2

2 carriage bolts 5/16" x 3/4"

2 flat washers 5/16"

2 Nylock 5/16"

Combine the cover baffle and the 2 z-bars.

Assemble them upside down to facilitate the assembly.

Insert the 2 bolts from the outside in.

Insert washers on the bolts.

Apply anti-seize to bolt threads.

Tighten nuts by hand only. Do not overtighten immediately, to align the bore on the hood.

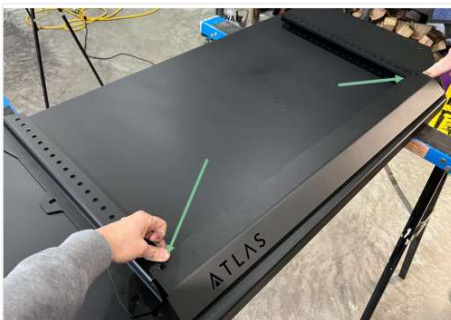

8. Install previous step assembly on the cover panel

Hardware bag #2

6 button head 5/16" x 3/4"

6 flat washers 5/16"

6 Nylock 5/16"

6 Sealing washers 5/16"

6 Sealing washers 5/16" in between plates (white ones)

Take the assembly from the previous step and place it on the cover. Align holes.

Insert sealing washers on the 5/16 bolts

Place the white sealing washers between Z-plates and cover

Insert the 6 bolts from the outside to the inside of the GoBOX, passing through the white sealing washer.

Apply anti-seize to bolt threads, flat washers and nylocks.

Tighten nuts.

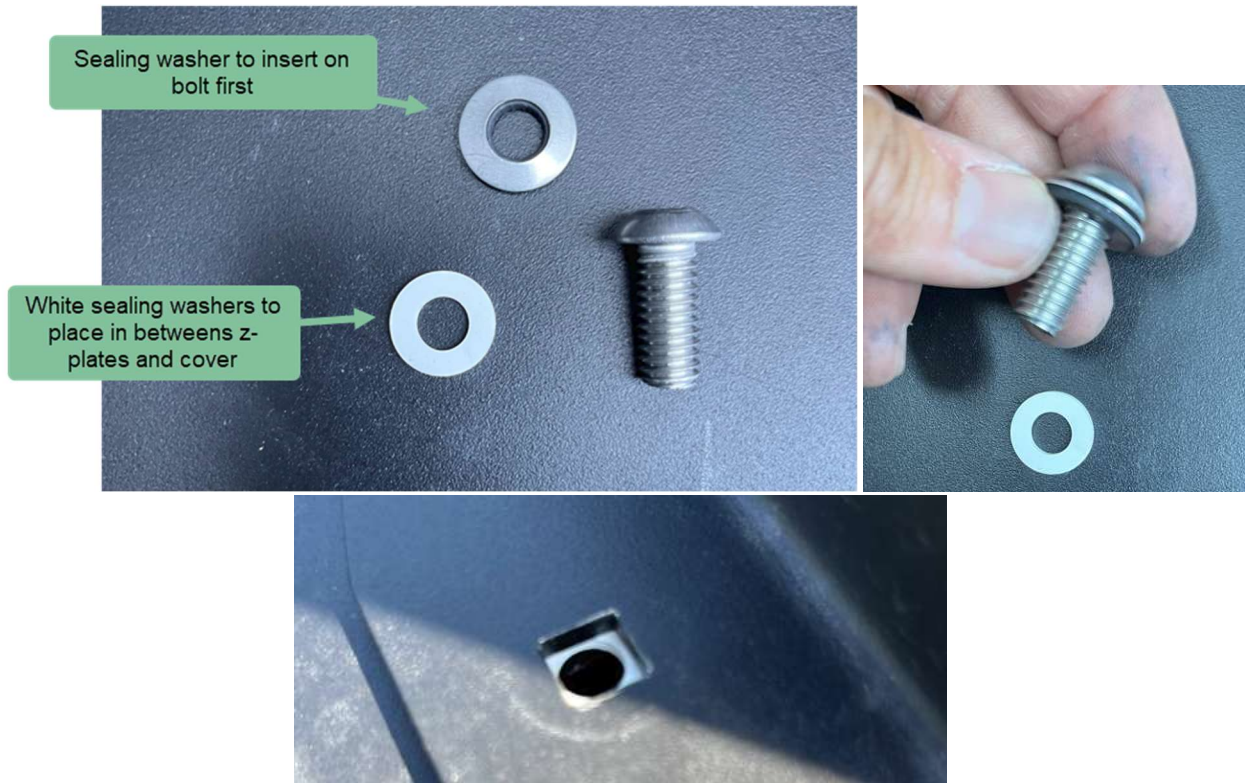

1



2



3

9. Install main hinges on the cover panel

Hardware bag #3

3 main hinges (bigger ones)

6 flat cap bolts $\frac{1}{4}$ " x $\frac{5}{8}$ "

6 flat washers $\frac{1}{4}$ "

6 THIN Nylock $\frac{1}{4}$ "

**** Be careful not to over tight****

Insert 2 bolts per hinge.

Insert the hinges with the bolts on the cover.

Insert washers on bolts.

Apply anti-seize to bolt threads.

Tighten nuts to prescribed torque..



1



2



3

10. Install gaz spring (rear panel side).

Hardware bag #4

1 gaz spring

3 button head bolt #10 x $\frac{5}{8}$ "

3 sealing washer #10

3 flat washers #10

3 Nylock #10

Insert sealing washers on bolt heads.

Insert the 3 bolts from the outside in.

Insert flat washers on the inside of the bolts.

Apply anti-seize to bolt threads.

Tighten nuts to prescribed torque.



1



2



3

11. Install cover panel on GoBOX

Hardware bag #3

3 x ½" shims (for main hinges on rear panel side)

6 flat cap bolts ¼" X 1-1/4"

6 flat washers ¼"

6 Nylock ¼"

Place the cover on the GOBOX



a) Install Hinge #1 (refer to picture above)

Insert a shim between hinge #1 (reference #1 image above) and the box.

Insert the 2, ¼" x 1 ¼" bolts through the hinge, shim and box.

Via the open side door, insert 2 washers. Apply anti-seize.

Hand tightens only for now.



1



2



3



4

b) Install main hinge #3

****Please note: this step must be performed by 2 people**.**

Lift the cover and hold it open using the hardware box in your packaging.

Repeat the same steps as for hinge #1.



c) Install main hinge #2

Repeat hinge #1 step

Adjust the cover and tightens all bolts

12. Install gaz spring (Cover side)

Hardware bag #4

3 button head bolts #10 x 5/8"

3 flat washers #10

3 Nylock #10

3 sealing washers #10

Insert sealing washers on bolts.

Insert the 3 bolts from the outside in.

Insert flat washers on the bolts and nylocks.

Apply anti-seize to bolt threads.



13. Install the lights and pass the 4-strand wiring over the steel tube in the bores provided.

Hardware bag #4

6 socket head #10" X 3/4"

6 flat washers #10

6 Nylocks #10

Remove the clipped red covers



Insert the 6" light wire into the holes in the angled panels.

Insert #10 socket head bolts through the holes in the lights and through the box.



Apply anti-seize to bolt threads.

Tighten the bolts and nuts.

Clip the red covers back on.



Install the license plate light with the black plastic cover facing upwards



Clip the electrical wiring to the lights, pass them through the holes provided and fasten them to the box with tie-wraps.
****Take care to associate Left and Right lights with the correct wiring identified as Left and Right****

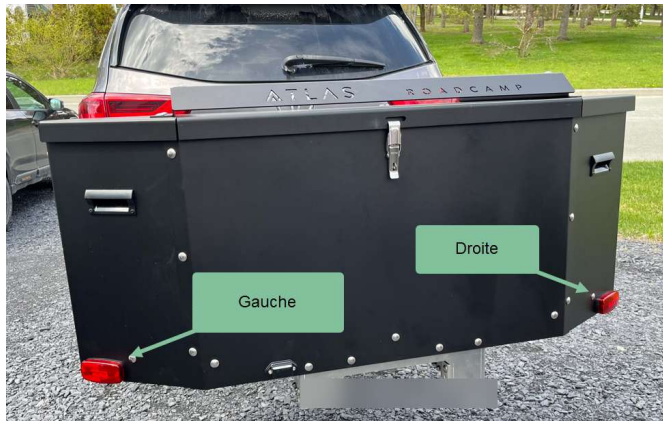



14. Install the GoBOX on the vehicles hitch.
Simply slide the 2" x 2" tube into the hitch and insert the 5/8" pin.

15. Install the anti-rattle system from the hitch to the steel tube

Important to tighten nuts and counter-nuts



ASSEMBLE BIKE RACK

A. Install the 2 cargo box to bike rack transition plates

6 Carriage bolts 5/16 X 3/4"

6 flat washers 5/16"

6 Nylock 5/16



****Note that there is a left and a right plate. The roll bar is located on the outside of the plates****

Insert the 6 bolts from the outside in.
Insert washers on the inside of the bolts.
Apply anti-seize to bolt threads.
Tighten as specified.

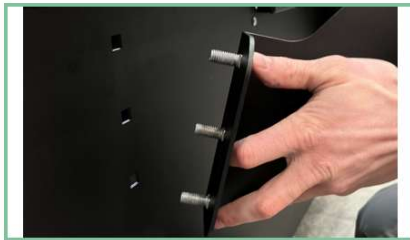

1



2

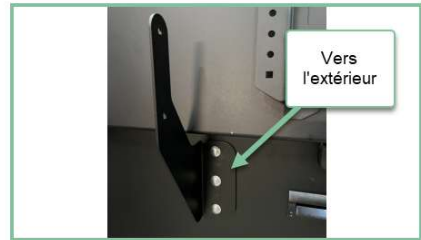

3

B. Install rolled bar

4 Carriage bolts 5/16" X 1-3/4"

4 Flat washer 5/16

4 Nylock 5/16



C. Install stabilizer arm

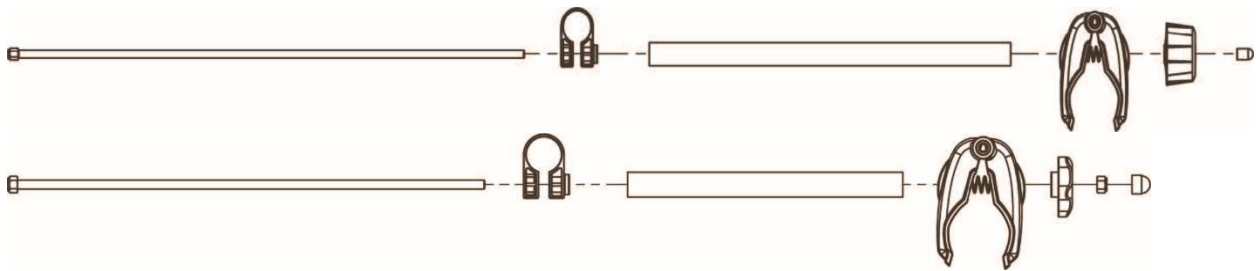

D. Install gutters on box Z-plates

4 Carriage bolts 5/16" x 3/4"

4 Flat washers 5/16"

4 Nylocks 5/16"

1. Insert the 4 bolts in the keyway



- Slide the wheel blocks onto the gutters. Both directions are good, you can confirm the direction when you install your bikes on the gutters.
4 Star-grips
4 Flat washers



- Align the gutters according to the distance between the stabilizer arms. Use your bike to confirm gutter location.

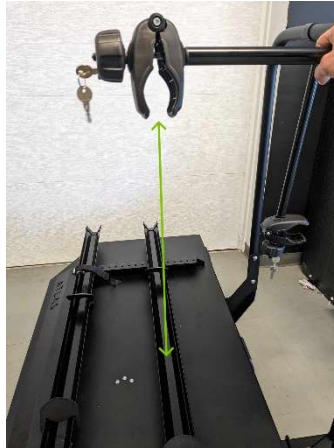

- Tighten the gutters with the nuts. Make sure the gutters are centered with the box.
4 flat washers 5/16"
4 Nylocks 5/16"



- Confirm the position of the wheel blocks according to the width of your bike and tighten the star grips under the wheel blocks.



6. Install plastic end caps on each gutter end.



OPERATING THE BIKE RACK FONCTIONNEMENT DU SUPPORT À VÉLOS

ARMS / BRAS

After securely placing your bikes within the designated gutters, the next step is to affix them to one of the support arms. You have the flexibility to fasten them using either the bike's frame (see figure A), the bench (see figure B), or even the front of your bicycle (see figure C), ensuring a secure and reliable attachment.

Après avoir placé vos vélos dans les gouttières prévues à cet effet, l'étape suivante consiste à les fixer à l'un des bras de support. Vous avez la possibilité de les fixer en utilisant le cadre du vélo (voir figure A), le banc (voir figure B) ou même l'avant du vélo (voir figure C), ce qui garantit une fixation sûre et fiable.



WHEEL STOPPER / CALES DE ROUE

After securely placing your bikes within the designated gutters, the next step is to affix them to one of the support arms. You have the flexibility to fasten them using either the bike's frame (see figure A), the bench (see figure B), or even the front of your bicycle (see figure C), ensuring a secure and reliable attachment.

Après avoir placé vos vélos dans les gouttières prévues à cet effet, l'étape suivante consiste à les fixer à l'un des bras de support. Vous avez la possibilité de les fixer en utilisant le cadre du vélo (voir figure A), le banc (voir figure B) ou même l'avant du vélo (voir figure C), ce qui garantit une fixation sûre et fiable.

